

KENWOOD

AV SURROUND STEREO AMPLIFIER

KA-V7500

INSTRUCTION MANUAL

KENWOOD CORPORATION

B60-0198-10 (J/A) (K, M, Y)
91/12 11 10 9 8 7 6 5 4 3 2 1 90/12

Introduction

Your choice of this product indicates that you are a devotee to excellence in sound reproduction.

We appreciate your patronage and take pride in the long tradition of quality components that our company represents.

So that you can get the most out of your unit, we suggest that you take the time to read through this manual before you hook up and operate your system. This will acquaint you with operating features and system-connection considerations so that your listening pleasure will be enhanced right from the start. You will notice that in all aspects of planning, engineering, styling, operating convenience and adaptability we have sought to anticipate your needs and desires.

Keep this manual handy for future reference.

For your records

Record the serial number, found on the back of the unit, in the spaces designated on the warranty card, and in the space provided below. Refer to the model and serial numbers whenever you call upon your dealer for information or service on this product.

Model _____ Serial Number _____

Unpacking

Unpack the unit carefully and make sure that all accessories are put aside so they will not be lost.

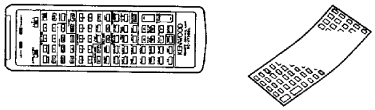
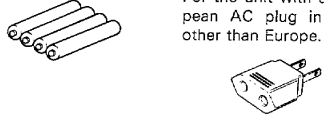

Examine the unit for any possibility of shipping damage. If your unit is damaged or fails to operate, notify your dealer immediately. If your unit was shipped to you directly, notify the shipping company without delay. Only the consignee (the person or company receiving the unit) can file a claim against the carrier for shipping damage.

We recommend that you retain the original carton and packing materials for use should you transport or ship the unit in the future.

Accessories	
Remote control unit 1	Remote control unit entry sheet 1
	
Batteries (R03/UM-4/"AAA") 4	AC plug adaptor 1 (Except for some areas.) For the unit with a European AC plug in areas other than Europe.
	

Contents

Caution: Read the pages marked  carefully to ensure safe operation.

Introduction	2	Playing back a video source	22
 Before applying power	3	Recording a video source	23
 Safety precautions	3	Independent audio/video recording from source being played	24
 IMPORTANT SAFEGUARDS	4	Surround effects	25
System connections	6	Dolby Surround adjustments	26
Controls and indicators	11	Playback with Surround effects	27
Remote control operation	12	Title Edit function	30
On-screen character display	18	In case of difficulty	32
Playing back an audio source	20	Specifications	33
Recording an audio source	21		

⚠ Caution: Read this page carefully to ensure safe operation.

Before applying power

For the U.S.A. and Canada

Important!

Units shipped to the U.S.A. and Canada are designed for operation on 120 volts AC only.

Safety precaution for a Polarized AC plug

However, some products may be supplied with a non-polarized plug.

CAUTION: TO PREVENT ELECTRIC SHOCK DO NOT USE THIS (POLARIZED) PLUG WITH AN EXTENSION CORD, RECEPTACLE OR OTHER OUTLET UNLESS THE BLADES CAN BE FULLY INSERTED TO PREVENT BLADE EXPOSURE.

For the United Kingdom

Important!

Units shipped to the U.K. are designed for operation on 240 volts AC only.

The mains plug must be removed from the wall socket prior to any internal examination.

The wires in this mains lead are coloured in accordance with the following code:

Blue Neutral
Brown Live

The wires in this mains lead must be connected to the terminals in the plug as follows:

Wire colour	Plug terminal marking
Blue	N or Black
Brown	L or Red

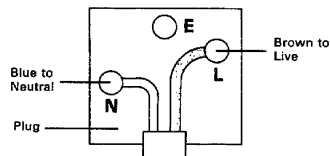

Notes:

1. If a 13-amp plug is used, this must be fitted with a 5-amp fuse.
2. If a 3-pin plug with earthing contact is used, no wire must be connected to the E terminal.

For Australia and Europe

Important!

Units shipped to Australia are designed for operation on 240 V AC only.

Units shipped to Europe are designed for operation on 220 V AC only.

For other countries

Important!

Units shipped to countries other than the above countries are equipped with an AC voltage selector switch on the rear panel. Refer to the following paragraph for the proper setting of this switch.

AC voltage selection

This unit operates on 110-120 or 220-240 volts AC. The AC voltage selector switch Type A or Type B on the rear panel is set to the voltage that prevails in the area to which the unit is shipped. Before connecting the power cord to your AC outlet, make sure that the setting position of this switch matches your line voltage. If not, it must be set to your voltage in accordance with the following direction.

Note:

Our warranty does not cover damage caused by excessive line voltage due to improper setting of the AC voltage selector switch.



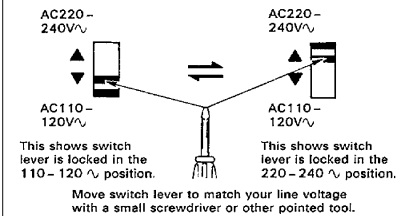

Type A



AC voltage selector switch

Safety precautions

WARNING: TO PREVENT FIRE OR SHOCK HAZARD, DO NOT EXPOSE THIS APPLIANCE TO RAIN OR MOISTURE.

 <p>CAUTION RISK OF ELECTRIC SHOCK DO NOT OPEN</p> 	<p>CAUTION: TO REDUCE THE RISK OF ELECTRIC SHOCK, DO NOT REMOVE COVER (OR BACK). NO USER-SERVICEABLE PARTS INSIDE, REFER SERVICING TO QUALIFIED SERVICE PERSONNEL.</p>
	<p>THE LIGHTNING FLASH WITH ARROWHEAD SYMBOL, WITHIN AN EQUILATERAL TRIANGLE, IS INTENDED TO ALERT THE USER TO THE PRESENCE OF UNINSULATED "DANGEROUS VOLTAGE" WITHIN THE PRODUCT'S ENCLOSURE THAT MAY BE OF SUFFICIENT MAGNITUDE TO CONSTITUTE A RISK OF ELECTRIC SHOCK TO PERSONS.</p>
	<p>THE EXCLAMATION POINT WITHIN AN EQUILATERAL TRIANGLE IS INTENDED TO ALERT THE USER TO THE PRESENCE OF IMPORTANT OPERATING AND MAINTENANCE (SERVICING) INSTRUCTIONS IN THE LITERATURE ACCOMPANYING THE APPLIANCE.</p>

IMPORTANT SAFEGUARDS

⚠ Caution : Read this page carefully to ensure safe operation.

Please read all of the safety and operating instructions before operating this unit. For best results, follow all warnings placed on the unit and adhere to the operating and use instructions. These safety and operating instructions should be retained for future reference.

1. Power sources — The unit should be connected to a power supply only of the type described in the operating instructions or as marked on the appliance.

2. Power-cord protection — Power-supply cords should be routed so that they are not likely to be walked on or pinched by items placed upon or against them, pay particular attention to cords at plugs, convenience receptacles, and the point where they exit from the unit.

Never pull or stretch the cord.



3. Grounding or polarization — The precautions should be taken so that the grounding or polarization means of this unit is not defeated.

4. Ventilation — The unit should be situated so that its location or position does not interfere with its proper ventilation.

To maintain good ventilation, do not put records or a table-cloth on the unit. Place the unit at least 10 cm away from the walls.

Do not use the unit on a bed, sofa, rug or similar surface that may block the ventilation openings.

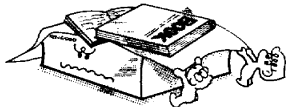

5. Water and moisture — The unit should not be used near water — for example, near a bathtub, washbowl, kitchen sink, laundry tub, in a wet basement, or near a swimming pool, etc.

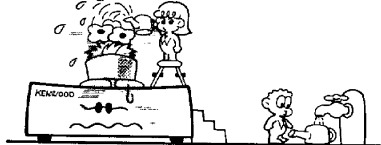

6. Temperature — The unit may not function properly if used at extremely low, or freezing temperatures. The ideal ambient temperature is above +5°C (41°F).

7. Heat — The unit should be situated away from heat sources such as radiators, heat registers, stoves, or other units (including amplifiers) that produce heat.

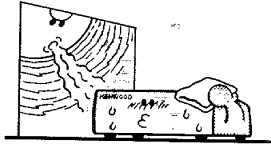

8. Electric shock — Care should be taken so that objects do not fall and liquid is not spilled into the enclosure through openings. If a metal object, such as a hair pin or a needle, comes into contact with the inside of this unit, a dangerous electric shock may result. For families with children, never permit children to put anything, especially metal, inside this unit.

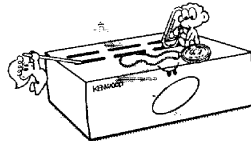

9. Enclosure removal — Never remove the enclosure. If the internal parts are touched accidentally, a serious electric shock might occur.

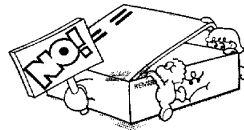

10. Magnetic fields — Keep the unit away from sources of magnetic fields such as TV sets, speaker systems, radios, motorized toys or magnetized objects.

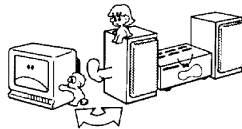

11. Cleaning — Do not use volatile solvents such as alcohol, paint thinner, gasoline, or benzine, etc. to clean the cabinet. Use a clean dry cloth.

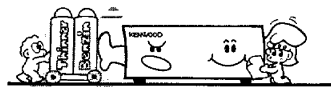

⚠ Caution : Read this page carefully to ensure safe operation.

12. Carts and stands — An appliance and cart combination should be moved with care. Quick stops, excessive force, and uneven surfaces may cause the appliance and cart combination to overturn.



13. Nonuse periods — The power cord of the unit should be unplugged from the outlet when left unused for a long period of time.

14. Abnormal smell — If an abnormal smell or smoke is detected, immediately turn the power OFF and pull out the power cord. Contact your dealer or nearest service center.

POWER OFF!



15. Damage requiring service — The unit should be serviced by qualified service personnel when:

- A. The power-supply cord or the plug has been damaged; or
- B. Objects have fallen, or liquid has been spilled into the unit; or
- C. The unit has been exposed to rain; or
- D. The unit does not appear to operate normally or exhibits a marked change in performance; or
- E. The unit has been dropped, or the enclosure damaged.

16. Servicing — The user should not attempt to service the unit beyond that described in the operating instructions. All other servicing should be referred to qualified service personnel.

17. Outdoor antenna grounding — If an outside antenna is connected to the receiver, be sure the antenna system is grounded so as to provide some protection against voltage surges and built up static charges. Section 810 of the National Electrical Code, ANSI/ NFPA No. 70—1984, provides information with respect to proper grounding of the mast and supporting structure, grounding of the lead-in wire to an antenna discharge unit, size of grounding con-

ductors, location of antenna-discharge unit, connection to grounding electrodes, and requirements for the grounding electrode. See Figure.

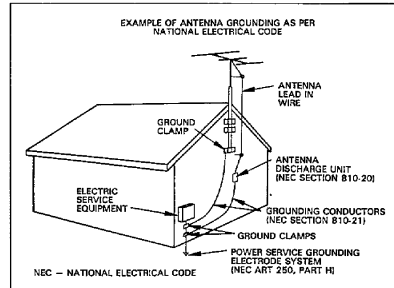

18. Power lines — An outdoor antenna should be located away from power lines.

19. AC outlets — Do not connect other audio equipment with a power consumption larger than that specified to the AC outlet on the rear panel. Never connect other electrical units, such as an iron or toaster, to it to prevent fire or electric shock.

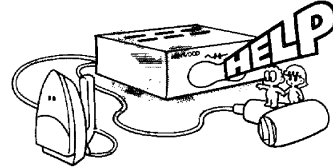

The maximum capacities indicated for the AC outlets on the rear panel of this unit are as follows.

SWITCHED outlets: 200 W

Notes:

- 1. Item 3 is not required except for grounded or polarized equipment.
- 2. Item 17 and 18 are not required except for units provided with antenna terminals.
- 3. Item 17 complies with UL in the U.S.A.

System connections

Connection of audio components

Make connection as shown in the diagram below. When connecting the related system components, refer also to the instruction manuals of the related components.
Do not plug in the power lead until all connections are completed.

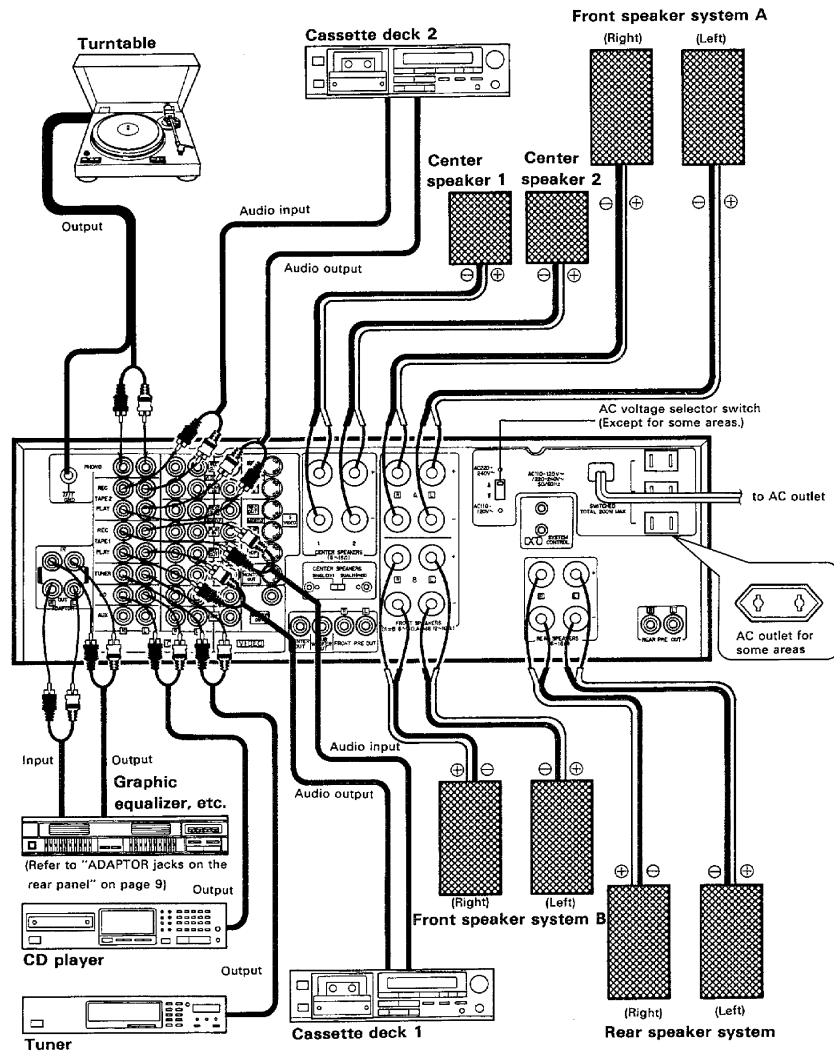

Notes:

1. Connect all cords firmly. If connections are loose there could be loss of sound or noise produced.
2. Do not connect up a power source which is larger than that indicated on the socket at the rear of the unit.
3. When plugging and unplugging connection cords after connections are complete, be sure to first remove the power cord from the AC outlet. Plugging/unplugging connection cords without removal of the power cord can cause malfunctions or damage to the unit.

Connection of video components

Make connection as shown in the diagram below. When connecting the related system components, refer also to the instruction manuals of the related components.
Do not plug in the power lead until all connections are completed.

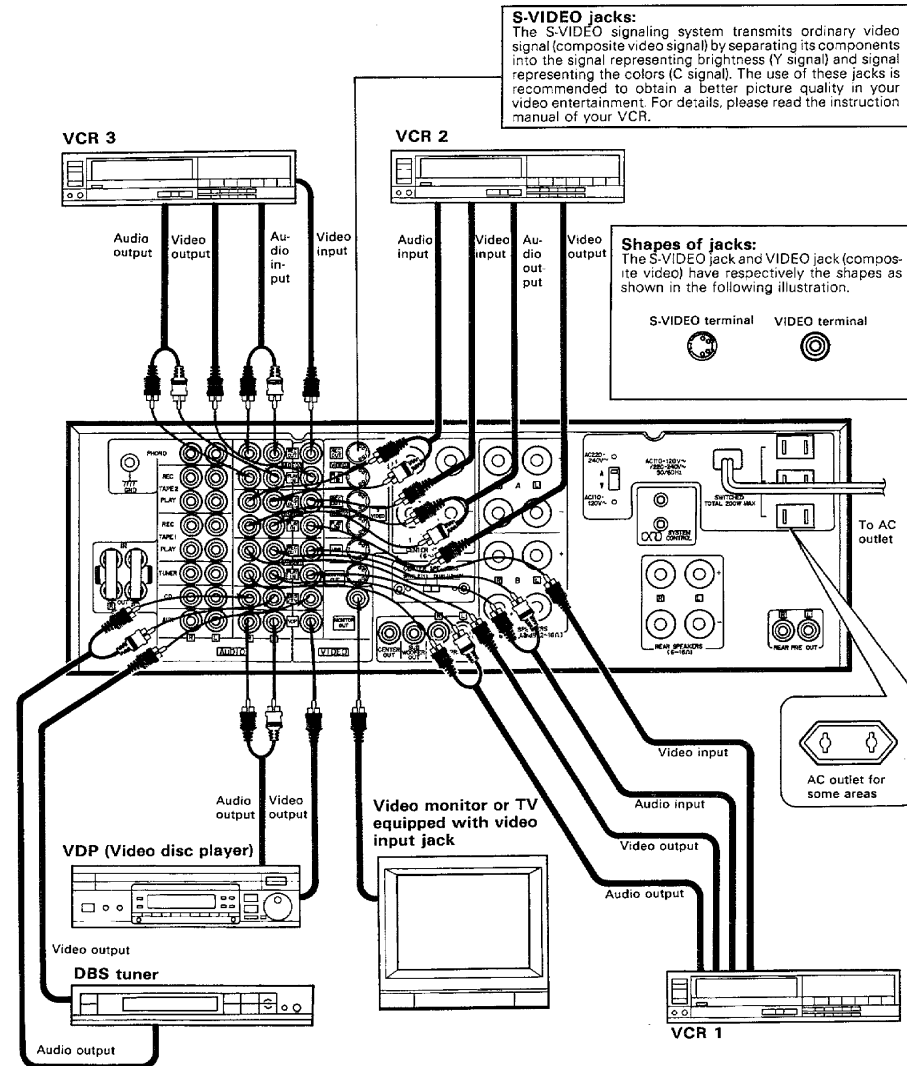

Notes:

1. Connect all cords firmly. If connections are loose there could be loss of sound or noise produced.
2. Do not connect up a power source which is larger than that indicated on the socket at the rear of the unit.
3. When plugging and unplugging connection cords after connections are complete, be sure to first remove the power cord from the AC outlet. Plugging/unplugging connection cords without removal of the power cord can cause malfunctions or damage to the unit.

■ Speaker connections

Connect the speakers as shown in the figure, paying attention to the core wires not to come contact with other jacks.

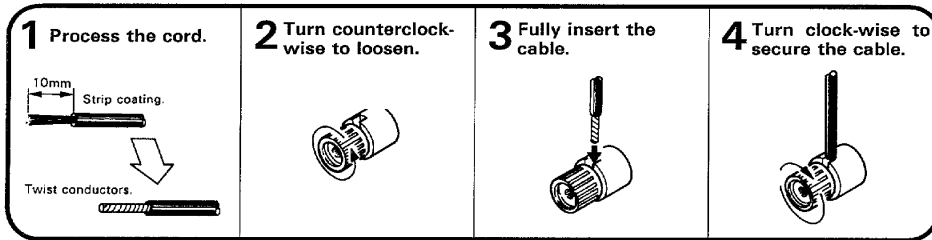

Caution concerning speaker connections

1. Set the POWER switch to OFF before connection the speaker cords.
2. After connecting the lead wires, verify that they do not come into contact with other terminals.
3. Never short-circuit the (+) and (-) speaker cords.
4. Be sure not to inverse the left and right speaker connections or the (+) and (-) terminal polarity. This will cause the acoustic image of instruments to be unclear and the sound to be unnatural.

WARNING!

Particular attention must be given to making good electrical contact at the amplifier-output and speaker terminals. Poor or loose connections can cause sparking or burning at the terminals because of the very high power that the amplifier can deliver.

Speaker impedance

- ① **Front speakers**
When only one pair of speakers is connected to A or B speaker terminals, use speakers having an impedance of 6 to 16 ohms.
When two pairs of speakers are connected to both A and B terminals simultaneously, use the speakers having an impedance of 12 to 16 ohms. In this case, connecting a speaker having an impedance of less than 12 ohms may cause malfunction of the amplifier.
- ② **Center speakers and rear speakers**
Use speakers having an impedance of 6 to 16 ohms. In this case, even if only one speaker has an impedance of less than 6 ohms, damage to the amplifier may occur.

CENTER SPEAKERS switch

This unit accepts the connection of one or two center speakers. Set the CENTER SPEAKERS switch according to the number of the center speakers used.

- ① **When only one center speaker is used**
It must be connected to **CENTER SPEAKERS 1**

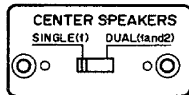

- Sound will not be output if the switch is left to the DUAL (1 and 2) position.

- ② **When two center speakers are used**

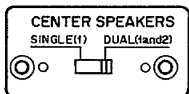

Connection of CENTER OUT jack

In addition to the CENTER SPEAKERS terminals, a CENTER OUT jack is provided on the rear panel of this unit. If you use an optional amplifier or a speaker with built-in amplifier, connect a speaker to this jack using an audio cord.

Note:

Sound cannot be output by simply connecting an ordinary speaker to the CENTER OUT jack. If the speaker you want to use as the center pre-out speaker does not incorporate a built-in amplifier, connect the CENTER OUT jack output to the AUX input jack of a separate, special-purpose amplifier, and connect the speaker to the amplifier connected to the CENTER OUT jack.

Connection of FRONT PRE OUT jacks

The built-in amplifier fully gives the joy of listening, but if you wish to obtain the louder sound or the tone of your choice from the front speakers, connect the FRONT PRE OUT jacks to an optional power amplifier and connect the front speakers to the power amplifier.

Note:

Sound cannot be output by simply connecting an ordinary speaker to the FRONT PRE OUT jack. If the speaker you want to use as the front pre-out speaker does not incorporate a built-in amplifier, connect the FRONT PRE OUT jack output to the AUX input jack of a separate, special-purpose amplifier, and connect the speaker to the amplifier connected to the FRONT PRE OUT jack.

Connection of REAR PRE OUT jacks

The surround effect can be obtained with the built-in amplifier. If you wish to obtain the louder sound or the tone of your choice from the rear speakers, connect the REAR PRE OUT jacks to an optional power amplifier and connect the rear speakers to the power amplifier.

Note:

Sound cannot be output by simply connecting an ordinary speaker to the REAR PRE OUT jack. If the speaker you want to use as the rear pre-out speaker does not incorporate a built-in amplifier, connect the REAR PRE OUT jack output to the AUX input jack of a separate, special-purpose amplifier, and connect the speaker to the amplifier connected to the REAR PRE OUT jack.

SUB WOOFER jack connection

A SUB WOOFER jack is provided on the rear panel of the unit. When connecting a sub-woofer or Super Woofer, connect it to this jack using an audio cord.

Note:

Sound cannot be output by simply connecting an ordinary speaker to the SUB WOOFER jack. If your sub-woofer speaker does not incorporate a built-in amplifier, connect the SUB WOOFER jack output to the AUX input jack of a separate, special-purpose amplifier, and connect the speaker to the amplifier connected to the SUB WOOFER jack.

ADAPTOR jacks on the rear panel

Use these jacks when a graphic equalizer, etc., is to be connected (refer to page 6).

When the ADAPTOR jacks are not used, be sure to insert shorting pins into them. No sound will be produced if nothing is inserted into these jacks.

Note:

If the shorting pins are removed to allow use of the ADAPTOR jacks, do not insert the pins into other jacks, for this will cause damage to the unit. Please retain them together with the Warranty Card and Instruction Manual.

Connection of video component

① Connection of monitor TV

Connect the video input jack of the monitor TV to the MONITOR OUT jack on the rear panel using a video connection cord.

If the monitor TV is equipped with an S-VIDEO input jack, connect it to the S-VIDEO jack of this unit.

Notes:

1. If the connection is made via the S-VIDEO jack, the features including the on-screen display is defeated.
2. Some TV accepts the S-VIDEO input in priority over the composite video input in case connection is made on both the S-VIDEO and composite VIDEO jacks. If on-screen display is required with such a TV with such a connection, disconnect its S-VIDEO jack.
3. When a video signal is input to this unit through the composite VIDEO jack, the same signal is not output from the S-VIDEO jack of the MONITOR OUT jacks.
4. When a video signal is input to this unit through the S-VIDEO jack, the same signal is not output from the MONITOR OUT video jack.

② Connection of VCRs

The VIDEO 2 and VIDEO 3 inputs/outputs can be connected through the S-VIDEO jacks. Therefore, dubbing between VCRs connected to VIDEO 2 and VIDEO 3 is available through the S-VIDEO jacks.

Note:

Dubbing between a VCR connected to a composite input/output and a VCR connected to an S-VIDEO input/output is not possible.

③ Connection of other video components

The S-VIDEO input jacks are also provided for the VDP and AV AUX inputs. Therefore, dubbing between VIDEO 2 and VIDEO 3 is also available through the S-VIDEO jacks.

Note:

Dubbing between a video component connected to a composite input/output and a video component connected to an S-VIDEO input/output is not possible.

Connection of other jacks

① Caution concerning connection to DBS/TV jacks

Be sure to connect the audio cords to the analog output jacks of the DBS/TV tuner. If the cords are connected to the digital output jacks, this unit or the BS tuner may be damaged.

② Connection of turntable unit

Connect a turntable equipped with an MM cartridge.

③ Connection to GND (ground) terminal

This terminal is for grounding use if a turntable is connected.

④ Connection to AUX input jacks

The auxiliary input jacks can be used for connecting an audio component such as a second tuner, etc.

■ Connection to SYSTEM CONTROL jacks

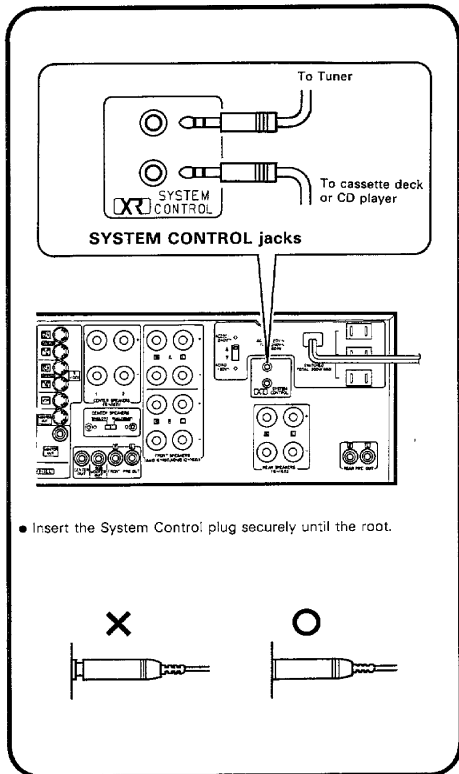

Connection to SYSTEM CONTROL jacks

These jacks are for use in controlling KENWOOD components as a system. By connecting these jacks to the SYSTEM CONTROL jacks of compatible KENWOOD components using the system control cords, the following operations can be performed.

What is System Remote Control

When the tuner, cassette deck and/or a CD player carrying the [XS] marking are connected to this unit via system control cords, all of the components can be remotely controlled with the remote control unit supplied with this unit.

External power supply outlets

SWITCHED outlets (total max. capacity 200W):

Connect the power plugs of the tuner, tape deck, turntable, or CD player to these outlets. By leaving the POWER switches of these components ON, they will be switched ON-OFF at the same time as the POWER switch of this unit. Never connect components having a total combined power consumption of more than total 200 W.

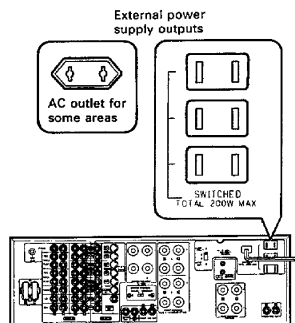

Display panel

The display shows the initiated operation when an operation key is pressed.

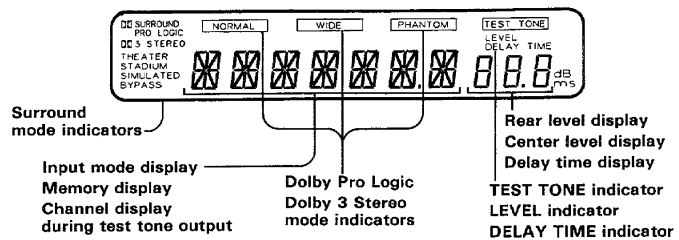

Controls and indicators

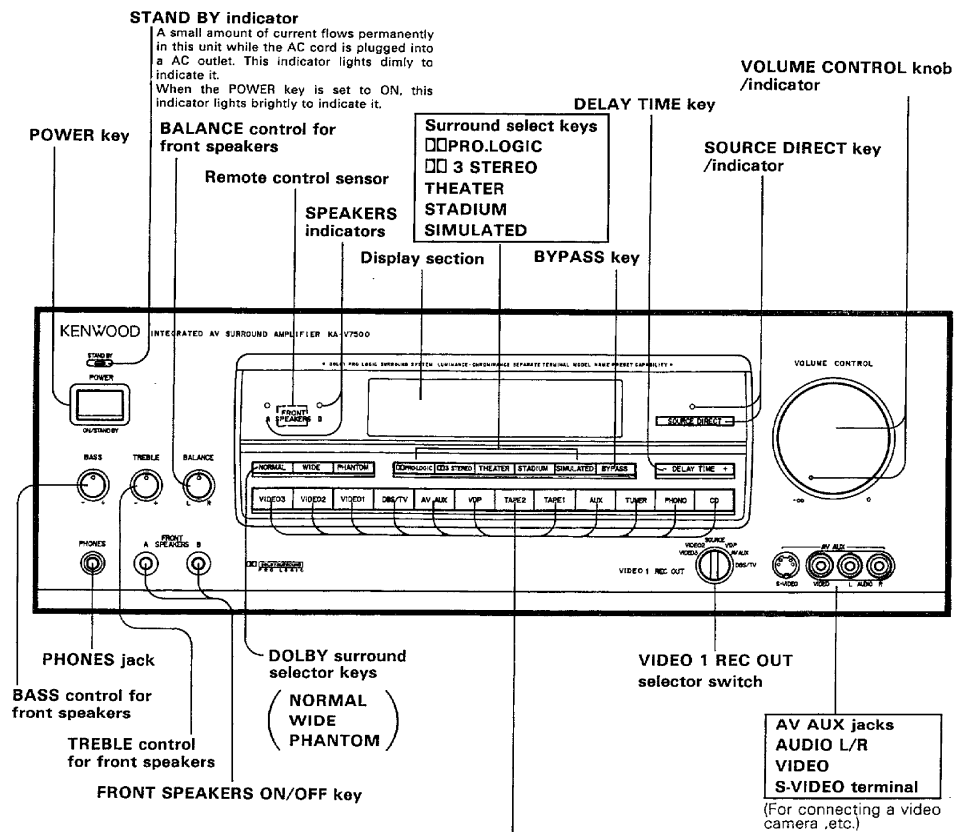

Input selector keys

Audio input selector keys

- CD:** For listening to CDs.
- PHONO:** For listening to records.
- TUNER:** For listening to radio broadcasts.
- AUX:** For listening to the component connected to the AUX jacks on the rear panel.
- TAPE1:** For listening to the tape deck connected to the TAPE1 jacks on the rear panel.
- TAPE2:** For listening to the tape deck connected to the TAPE2 jacks on the rear panel.

Video input selector keys

- VDP:** For playing the component connected to the VDP jacks on the rear panel.
- AV/AUX:** For playing the auxiliary video component connected to the AV/AUX jacks.
- DBS/TV:** For operating a DBS tuner or TV tuner.
- VIDEO1:** For playing VCR1.
- VIDEO2:** For playing VCR2.
- VIDEO3:** For playing VCR3.

Remote control operation

■ Loading batteries

1 Remove the battery cover.

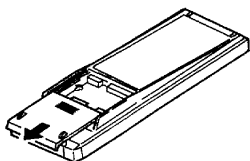

- While gently pressing the battery cover located on the rear of the remote control unit, slide it in the direction of the arrow.

2 Insert the provided four batteries.

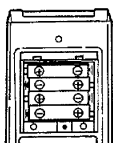

- Make sure that the batteries are inserted as indicated with the polarity markings on the bottom.

Note:
The batteries provided are to be used for checking the remote control operations. Their service life may be short.

3 Close the battery cover.

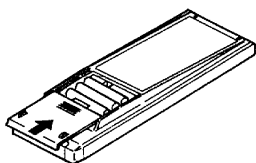

Replacing batteries

1. If the TRANSMIT indicator does not light even when the operation key is pressed, the batteries are exhausted. Replace the batteries. We recommend that the alkaline batteries (LR03/AM-4) which have longer service life be used.
2. The programmed contents are not immediately lost when the batteries are removed for replacement. However, they could be lost if the unit is left without batteries for more than 3 minutes. In such a case, the programming should be performed again. The function signals of the non-learning, or fixed keys are not lost even in this case.

Note:
Avoid using old and new batteries together, as this may cause corrosion.

■ Operating range of the remote control unit

The normal operating range may change depending on temperature, humidity, and other environmental conditions, but it is roughly specified as shown in the figure.

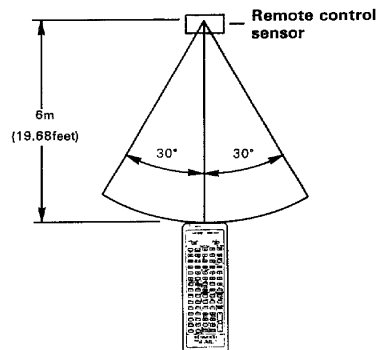

Model name: RC-V7500L
Transmission system:
Infrared pulse system

- Note:**
1. If two or more remote control operation keys are to be pressed successively, press each key securely and leave an interval of more than 1 second between presses. Pressing a key immediately after pressing another key may cause malfunction.
 2. Malfunction may occur in case direct sunlight or the light of a high-frequency lighting fluorescent lamp enters the remote control light receptor. In such a case, change the installation position of the unit so that the malfunction does not occur.

■ Operation of audio components (1)

(when components manufactured by KENWOOD are used)

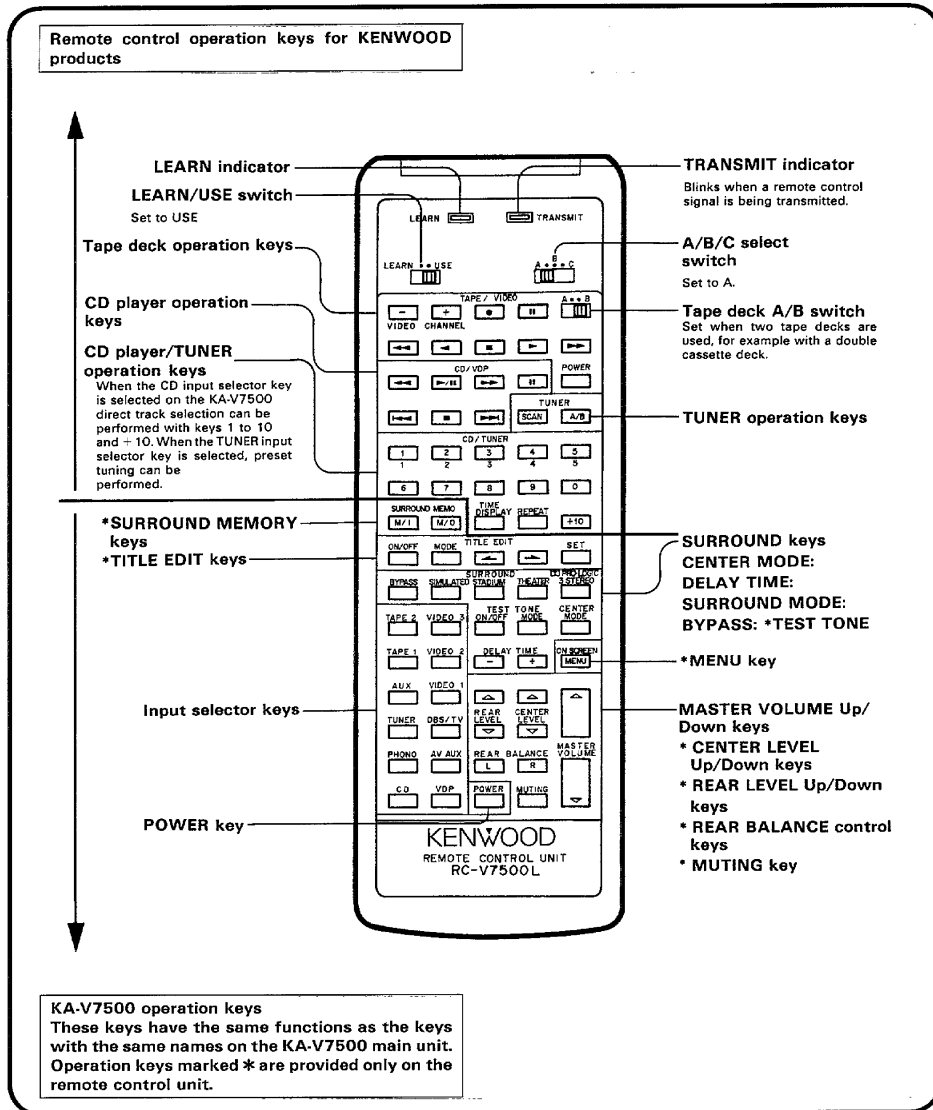

Caution in remote control

If the CD player is not equipped with the System Control jack, it cannot be operated properly from this remote control unit. In such a case, please use the remote control unit provided with the CD player.

The provided remote control unit is capable of "learning", or programming the functions of the remote control units of other A/V components in a single unit.

■ Operation of audio components (2)

(When components from manufactures other than KENWOOD are used)

Remote control operation keys for non-KENWOOD audio components

Set to USE. (Callout to LEARN + USE key)

Set to A (Callout to A+B key)

Tape deck A/B switch
Set when two tape decks are used for example with a double cassette deck.

*** SURROUND MEMO keys**

M/I keys
Memory Input key. Press to save a Surround setting in memory.

M/O key:
Memory Output key. Press to save a Surround setting in memory.

DELAY TIME keys
Press to set the delay time (delay on the rear speaker output with respect to the front speaker output) as desired.

*** CENTER MODE key**
Every time this key is pressed, the center mode is switched between NORMAL, WIDE and PHANTOM, in cyclical sequence.

*** MENU key**
Press to display the various operating conditions on the screen of the monitor TV.

MUTING key:
Press to mute the sound temporarily. To cancel muting, press this key again.

KA-V7500 operation keys
These keys have the same functions as the keys with the same names on the KA-V7500 main unit. Operation keys marked * are provided only on the remote control unit.

The remote control functions of other audio components can be programmed (stored) under these keys. For the programming method, refer to page 16.

KENWOOD REMOTE CONTROL UNIT RC-V7500L

■ Operation of video components

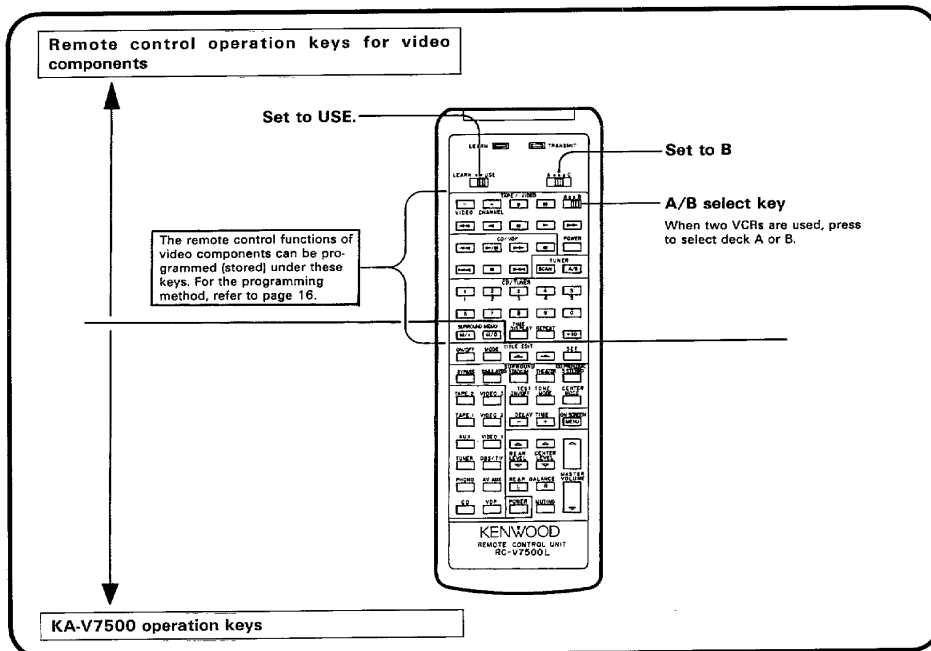

■ Using the whole of remote control unit panel as the programmable keys.

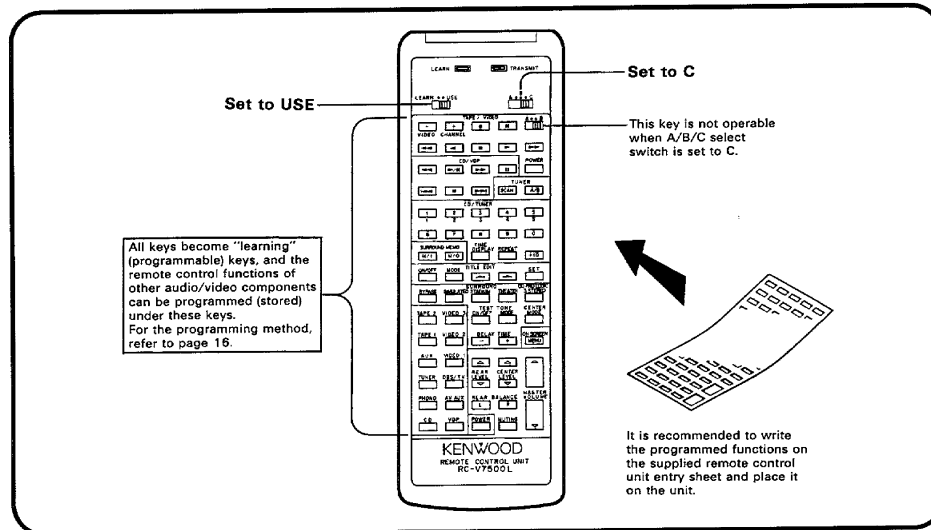

■ How to program the remote control functions of other components under the "learning" keys of this remote control unit

1 Set the LEARN/USE switch to LEARN.

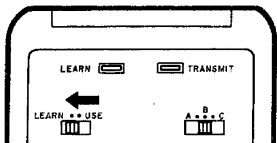

2 Set the A/B/C select switch to the desired position.

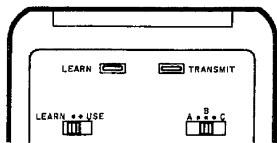

3 Place the remote control unit of another component with this remote control unit (RC-V7500L) so that their heads (signal transmitters) face each other.

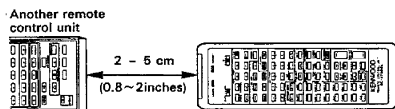

4 Press the learning key of RC-V7500L under which you want to program the function signal.

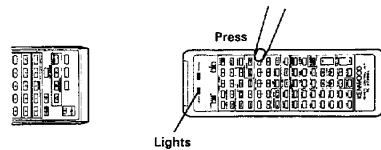

- LEARN indicator will light up.

5 Within 30 seconds after pressing the key above, press and hold the key of the other remote control unit which contains the function to be programmed (stored).

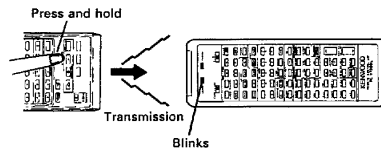

- The LEARN indicator changes from steady lighting to blinking, indicating that the function signal is being programmed.

6 When the LEARN indicator goes off after blinking twice, release your finger from the key of the other remote control unit

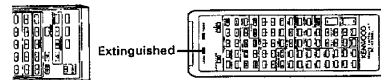

- Be sure to hold the key of the other remote control unit depressed until the LEARN indicator goes out.
- The programming is completed when the LEARN indicator goes out after two times of blinking.
- To program another function signal under another key, repeat steps 4 to 6 above.

■ To check the programmed (stored) contents

1 Set the LEARN/USE switch to USE.

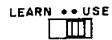

2 Press the key you want to check the function of.

3 Check to see if the intended function is activated.

■ To change the programmed (stored) contents

Re-start the programming (storing) operation.

- The previously-programmed contents are cleared automatically and replaced by the newly-programmed contents.

■ To perform normal remote control operation

1 Set the LEARN/USE switch to USE.



2 Press the "learning" key under which the required function signal has been programmed.

- The TRANSMIT indicator blinks and the remote control function is performed.

■ To clear the whole of the programmed (saved) contents

1 Set the LEARN/USE switch to LEARN.

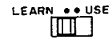

2 Press one of the "learning" keys.

- The LEARN indicator lights up.

3 Remove the battery case cover on the rear of the remote control unit.

4 Press the Reset key inside the battery case with a ball-point pen tip, etc.

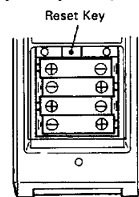

- All of the previously-programmed contents are cleared simultaneously and the remote control unit is reset to the initial condition.

Remote control unit entry sheet

It is recommended to write the programmed functions on the supplied remote control unit entry sheet. Use an oil-link felt pen or pencil. To erase, rub strongly with an ordinary eraser.

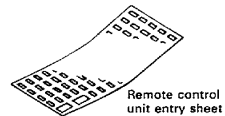

Almost all of the remote control systems used with other AV components use the same infrared system as this unit. This means that this unit is capable of programming the functions of almost all remote-controllable components. Before programming, please read carefully the instruction manuals of other AV components as well as this Instruction Manual.

Notes:

1. If the optical output power of the other remote control unit is too large, programming could fail. In such a case, place the remote control unit at a greater distance from this remote control unit.
2. If both the LEARN indicator and TRANSMIT indicator blink simultaneously, either the key is not a "learning" key which can be used for programming or the current programming is incomplete. In such cases, program the function again under a "learning" key.
3. Programming is also impossible if the other remote control unit uses a signal format other than the infrared system, if it uses a special signal modulation format, or if the storage capacity of this unit has become full.
4. 30 seconds after a "learning" key is pressed, the LEARN indicator goes from on to off (extinguished). As programming is impossible while the indicator is off, press the "learning" key again to light the indicator.
5. If more than one "learning" key is pressed, the function signal is programmed under the last pressed key.
6. Never attempt to program (store) the remote control functions of appliances other than AV components, such as air conditioners.

On-screen character display

Every time an operation is done, the on-screen character display appears on the TV screen, making it possible to check the current operation mode (selector position, Surround mode, input list, Surround memory title list, etc.). It is also possible to switch the on-screen character display on and off.

■ To check the current mode information

1 Press the MENU key on the remote control unit.

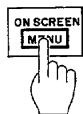

• The TV screen changes to the condition shown in Fig. (A)

2 With the screen display above, press the MENU key again.

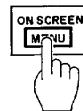

• Every time the key is pressed, the display changes from Fig. (A) to Fig. (G) repeatedly in cycle.

Notes:

1. On-screen displays shown in Fig. (A) and Fig. (G) remains for about 1.5 second. Other displays will not change until the MENU key is pressed.
2. If the above cycle is terminated with "INFORMATION OFF" display, the on-screen character display will not appear in later operations.
3. If it is required to have on-screen character display afterward, terminate the cycle with "INFORMATION ON".

To obtain the on-screen character display, connect a monitor TV to the VIDEO output jack.

The on-screen character display is not available in case the connection is made through the S-VIDEO jacks.

If the connection to the monitor TV is made via the S-VIDEO jack on the rear panel, the on-screen display is defeated. To obtain this function, disconnect the S-VIDEO cable and connect the monitor TV via the MONITOR OUT (VIDEO) jack.

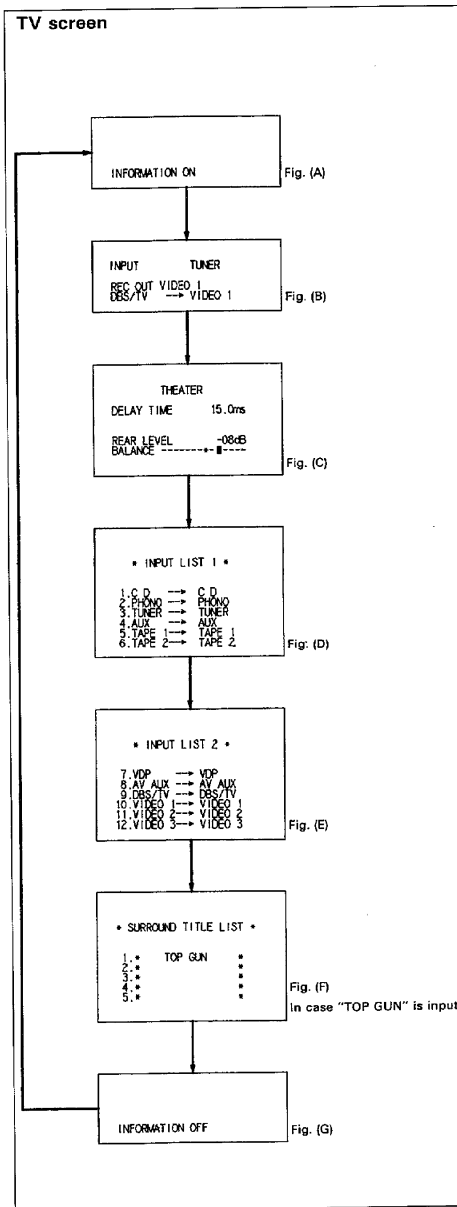

Input Mode Display

① INPUT Display

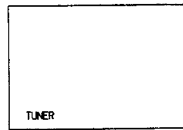

- The source selected with the SELECTOR switch is displayed.
- If no other video signal is input the screen background of monitor TV becomes:
 - { Audio input → Green background }
 - { Video input → Blue background }

② The source being output at the VIDEO 1 REC jack is displayed.



- If no other video signal is input the screen background of monitor TV becomes pink.

Surround displays

① The Surround mode selected by the SURROUND mode key is displayed.

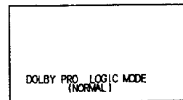

② The delay time is displayed in 0.5 ms steps.

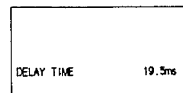

③ The rear level and the balance of the Surround mode are displayed.

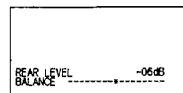

④ The CENTER level is displayed in the NORMAL and WIDE modes of Dolby Pro Logic and Dolby 3 Stereo.

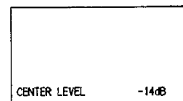

TEST TONE Display

① Dolby Pro Logic (NORMAL, WIDE)

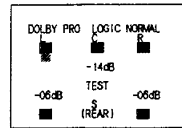

② Dolby Pro Logic (PHANTOM)

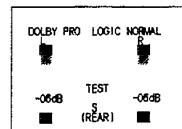

③ Dolby 3 Stereo (NORMAL, WIDE)

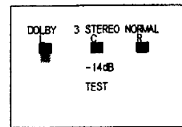

- In the Test mode of Dolby Pro Logic or Dolby 3 Stereo mode, the positions of the speakers through which the test tone is output are displayed.

Playing back an audio source

■ Basic operation procedure

1 Minimize the volume.

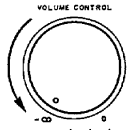

- Turn the VOLUME CONTROL fully counterclockwise.

2 Press the POWER key to ON.

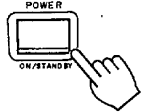

- The indicator lights up and the unit enters operation mode.

3 Press the FRONT SPEAKERS key to ON.



- The SPEAKERS indicators light up.

4 Select the desired source to be played.

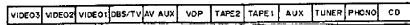

5 Play the selected source component.

6 Adjust the volume.

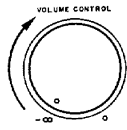

7 Adjust the balance.

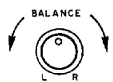

To attenuate the right speaker volume

To attenuate the left speaker volume

8 Adjust the tone.

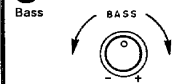

To attenuate the low frequencies

To enhance the low frequencies

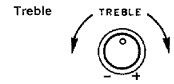

To attenuate the high frequencies

To enhance the high frequencies

■ How to listen through headphones

1 Insert the headphone plug into the PHONES jack.



2 Turn the speakers OFF.



- The SPEAKERS indicators go out.
- When the sub-woofer and Surround speakers have also been used, turn the sub-woofer power OFF, and press the Surround BYPASS key to bypass the Surround circuitry.

3 Adjust the volume.

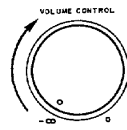

SOURCE DIRECT key

When the SOURCE DIRECT key is pressed in the BYPASS mode, the indicator above the key lights up, and the source selected by the input selector key can be enjoyed at a higher sound quality. In this case, however, the tone cannot be adjusted because the audio signal bypasses the tone control (BASS, TREBLE) and balance circuitry.

Note:

The SOURCE DIRECT function is canceled automatically when one of the Surround modes is selected.

STAND BY mode of POWER key

When the power cord of this system is plugged into an AC outlet, the STAND BY indicator lights up regardless of the ON/OFF setting of the POWER key. This indicates that a small amount of current is being supplied to the unit to back up the memory contents. This mode is referred to as the Stand By mode. While the STAND BY indicator is lit, the power of the system can be switched ON/OFF from the remote control unit.

Recording an audio source

■ How to record sound on cassette decks connected to the TAPE 1 and TAPE 2 jacks

1 Select the recording source.

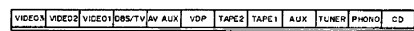

2 Start recording on the cassette deck(s).

- Simultaneous recording on TAPE 1 and TAPE 2 is possible.

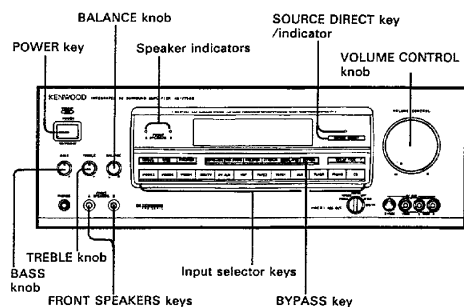

■ How to dub sound from cassette deck 1 (connected to TAPE 1 jacks) to cassette deck 2 (connected to TAPE 2 jacks)

1 Press the TAPE 1 input selector key.



2 Start recording on cassette deck 2.

3 Start playing cassette deck 1.

- The sound output from cassette deck 1 can be monitored during dubbing.

■ How to dub sound from cassette deck 2 (connected to TAPE 2 jacks) to cassette deck 1 (connected to TAPE 1 jacks)

1 Press the TAPE 2 input selector key.



2 Start recording on cassette deck 1.

3 Start playing cassette deck 2.

- The sound output from cassette deck 2 can be monitored during dubbing.

Notes:

1. If the selected dubbing source is a video component, only its sound will be recorded on the cassette tape.
2. The signal dubbed, or recorded on the cassette decks cannot be processed by the Surround or tone control circuitry.

Playing back a video source

■ How to play a video source

1 Switch ON the power of the monitor TV connected to the MONITOR OUT jacks.

- If the monitor TV is equipped with the S-VIDEO jack, the monitor TV and this unit can be connected using both the video cord and S-VIDEO cord. However, some monitor TV is automatically switched to the S-VIDEO input if both connections are made and, as a result, the on-screen character display does not appear. If you want the on-screen character display in such a case, unplug the S-VIDEO cable and use only the composite video input.

2 Select the video source to be viewed.

VIDEO3 VIDEO2 VIDEO1 DBS/TV AV AUX VDP



3 Start playing the selected video component.

- The picture is reproduced on the monitor TV screen, and the sound is reproduced through the speakers.

4 Adjust the sound.

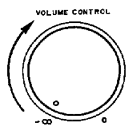

- The audio operation procedure is the same as that described in "Playing back an audio source".

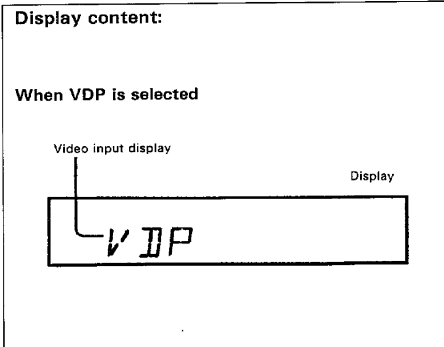
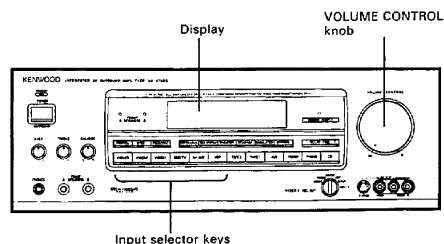

Note:

The characters "VIDEO 1" in the display window will blink if the VIDEO 1 is selected with the input selector key when the VIDEO 1 REC OUT selector switch is set to either VIDEO 2 or VIDEO 3. In this case, set the VIDEO 1 REC OUT selector switch to SOURCE.

Recording a video source

■ How to record audio/video to the VCR 1 (connected to VIDEO 1 jacks)

1 Set the VIDEO 1 REC OUT switch to SOURCE.

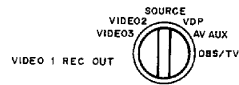

2 Select the source to be recorded.

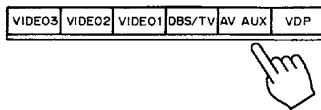

3 Start recording on VCR 1.

- The selected source being recorded can be monitored on the monitor TV during recording.
- The same audio/video signals can be recorded simultaneously on VCR 1, 2 and 3.
- The VIDEO 1 output can be recorded independently from the source being played. For details, please refer to page 24.

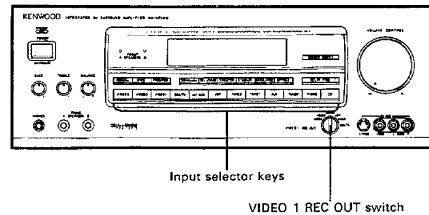

■ How to record audio/video to the VCR 2 (connected to VIDEO 2 jacks)

1 Set the VIDEO 1 REC OUT switch to SOURCE.

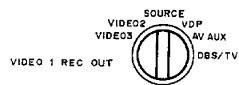

2 Select the source to be recorded.

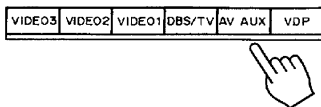

3 Start recording on VCR 2.

- The selected source being recorded can be monitored on the monitor TV during recording.
- The same audio/video signals can be recorded simultaneously on VCR 2 and 3.

■ How to record audio/video to the VCR 3 (connected to VIDEO 3 jacks)

1 Set the VIDEO 1 REC OUT switch to SOURCE.

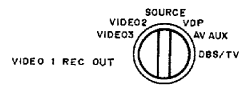

2 Select the source to be recorded.

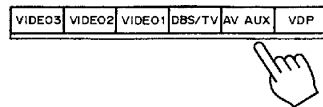

3 Start recording on VCR 3.

- The selected source being recorded can be monitored on the monitor TV during recording.
- The same audio/video signals can be recorded simultaneously on VCR 2 and 3.

Independent audio/video recording from source being played

The VIDEO 1 REC OUT switch of this unit allows to record the audio/video signals onto the VCR 1 independently from the source selected for playback.

■ How to record audio/video on VCR 1 independently from the source being played

1 Select the source to be played back.

VIDEO3 VIDEO2 VIDEO1 DBS/TV AV AUX VDP TAPE2 TAPE1 AUX TUNER PHONO CD



2 Select the source to be recorded onto the VCR 1.

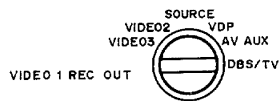

- If the switch is set to SOURCE, the source selected by the input selector key will be recorded.

3 Start recording on the VCR 1.

- You can listen to the source selected by the input selector key, while the VCR 1 records the source selected by the VIDEO 1 REC OUT switch.

Note:

If the VIDEO 1 REC OUT selector is set to VIDEO 2 or VIDEO 3 while VIDEO 1 has been selected by the input selector keys, characters "VIDEO 1" on the display blinks. In this case, select other source than VIDEO 1 by the input selector keys and try again.

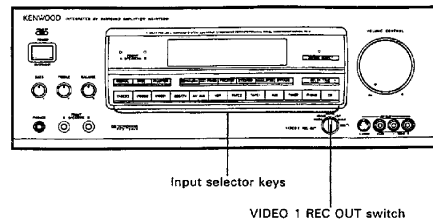

Example of on-screen character display

This unit incorporates the model name preset function (see page 30). This function allows to store the model names of other system components so that you can record them by identifying them with the model names.

When the DBS/TV input is recorded to the VIDEO 1 (KV-D958S) output, while the tuner (KT-5020) broadcast input is played.

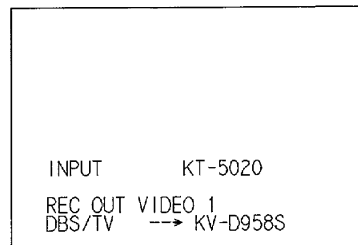
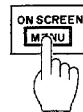

Surround effects

What is Surround effects

The reason why the sound you experience in concert halls or stadiums is so real and live is that the sound comes not only from the front but also from the surroundings. To reproduce such conditions as close as possible to reality, this unit is equipped with five Surround modes (DOLBY PRO LOGIC, DOLBY 3 STEREO, THEATER, STADIUM and SIMULATED). In addition, the Dolby Pro Logic mode includes three modes – NORMAL, WIDE and PHANTOM, and the Dolby 3 Stereo mode includes two modes – NORMAL and WIDE.

① DOLBY SURROUND (DOLBY PRO LOGIC, DOLBY 3 STEREO)

Video software marked "DOLBY SURROUND" are encoded with Dolby Surround information. This unit incorporates Dolby Pro Logic Surround and Dolby 3 Stereo decoder for recreating the Dolby Stereo theatre experience in your home with Dolby Surround encoded source material.

- DOLBY PRO LOGIC:** Use this mode when five or four speakers are used as shown in ①, ② or ③ in the illustrations on the right.
- DOLBY 3 STEREO:** This mode allows to obtain a Dolby Surround effect without using the rear speakers, as shown in ④ and ⑤ in the illustrations on the right.

② THEATER Surround

The Theater mode is for use with sources that have not been encoded with Dolby Surround signals. This mode provides a reverberation effect similar to that obtained in movie theaters.

③ STADIUM Surround

The Stadium mode provides the live, "being-there" feeling obtained when watching baseball or football games in a stadium.

④ SIMULATED Surround

With this mode, stereo effect is applied to a monaural source.

Manufactured under license from Dolby Laboratories Licensing Corporation. Additionally licensed under one or more of the following patents: U.S. numbers 3,632,886, 3,746,792 and 3,959,590; Canadian numbers 1,004,603 and 1,037,877. "Dolby" and the double-D symbol  are trademarks of Dolby Laboratories Licensing Corporation.

Dolby Surround center modes (PRO LOGIC, 3 STEREO)

Select the center mode according to the type of the center speaker used, so that the Dolby Surround effect can be exhibited at maximum.

① PRO LOGIC NORMAL:

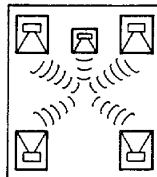

Use this mode when the signal output from the CENTER SPEAKERS terminals or CENTER OUT jack on the rear panel is reproduced using a compact center speaker. Low frequencies below 100 Hz of the signal are distributed to the left and right channels of the front speakers, and frequencies above 100 Hz are reproduced through the center speaker.

② PRO LOGIC WIDE:

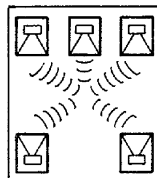

Use this mode when the signal output from the CENTER SPEAKERS terminals or CENTER OUT jack on the rear panel is reproduced using a medium-sized or larger center speaker. Low frequencies below 100 Hz of the signal are also sent to the center speaker without being distributed to the left and right channels of the front speakers.

③ PRO LOGIC PHANTOM:

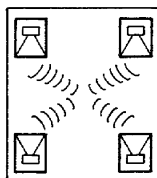

Use this mode when the center speaker is not used. The signal which is usually sent to the center speaker is distributed to the left and right channels of the center speaker.

④ 3 STEREO NORMAL:

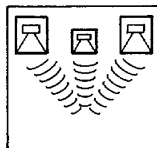

Use this mode when a compact speaker is used as the center speaker like in the NORMAL mode of the DOLBY PRO LOGIC mode.

⑤ 3 STEREO WIDE:

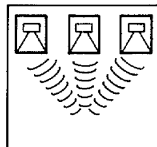

Use this mode when a medium-sized or larger speaker is used as the center speaker like in the WIDE mode of the DOLBY PRO LOGIC mode.

Dolby Surround adjustments (Remote control unit)

■ Adjustments in NORMAL or WIDE mode (in DOLBY PRO LOGIC or 3 STEREO mode)

1 Enter the DOLBY PRO LOGIC or 3 STEREO mode.



- The DOLBY PRO LOGIC mode and 3 STEREO mode are alternated every time the key is pressed.

2 Select the NORMAL or WIDE mode.



- Every time the CENTER MODE key is pressed, the center modes of the DOLBY PRO LOGIC mode are switched in the following order: NORMAL → WIDE → PHANTOM

The center modes of the 3 STEREO mode are switched alternately as follows:
NORMAL ↔ WIDE

3 Turn the test tone ON.



- Press from your listening position.

4 Press the TEST TONE MODE key.



- Every time the key is pressed, a noise-like test tone is output from different types of speakers in order from Left → Center → Right → Rear (Rear speaker sound is not output in the 3 STEREO mode).

5 Adjust so that the volumes from the five speakers are almost equal.



- The rear speakers are not used in the 3 STEREO mode. In this case, therefore, adjust so that the volumes from the three front speakers are equal.
- The REAR BALANCE controls are adjusted to make the volumes from the two rear speakers equal.

6 Terminate the adjustment.

- Press the TEST TONE ON/OFF key to OFF.

■ Adjustments in PHANTOM mode (in DOLBY PRO LOGIC mode only)

1 Enter the DOLBY PRO LOGIC mode.



- The DOLBY PRO LOGIC mode and 3 STEREO mode are alternated every time the key is pressed.

2 Select the PHANTOM mode.



- Every time the CENTER MODE key is pressed, the center modes of the DOLBY PRO LOGIC mode are switched in the following order: NORMAL → WIDE → PHANTOM

3 Turn the test tone ON.



- Press from your listening position.

4 Press the TEST TONE MODE key.



- Every time the key is pressed, a noise-like test tone is output alternately from the front and rear speakers.

5 Adjust so that the volumes from the four speakers are almost equal.



- The REAR BALANCE controls are adjusted to make the volumes from the two rear speakers equal.

6 Terminate the adjustment.

- Press the TEST TONE ON/OFF key to OFF.

■ Adjustments in input balance

The input balance is adjusted automatically.

"This unit features an automatic input balance control, eliminating the need to adjust L/R input balance for different sources and optimizing performance of the Dolby Pro Logic Surround/Dolby 3 Stereo decoding by minimizing crosstalk."

Playback with Surround effects

■ Adjustments in the THEATER, STADIUM or SIMULATED mode

1 Play a source component connected to this unit.

2 Select the desired mode.

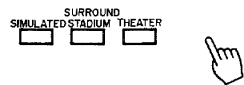

3 Adjust the rear speaker volume.



■ How to play with Surround effects

1 Select the desired Surround mode.

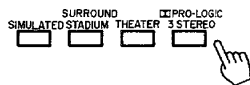

2 Adjust the volume.

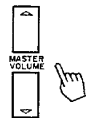

- The MASTER VOLUME keys adjust the volumes of all speakers simultaneously.

3 Set the desired delay time.

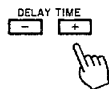

- Refer to "How to set the delay time" on page 28.
- In the DOLBY PRO LOGIC mode, the delay time can be set within the range from 15 to 30 ms in 0.5 ms steps.
- In the THEATER mode, the delay time can be set within the range from 0 to 99.5 ms in 0.5 ms steps.
- In the STADIUM and SIMULATED modes, the delay time is fixed and not displayed.
- In the DOLBY 3 STEREO mode, the delay time can not be adjusted.

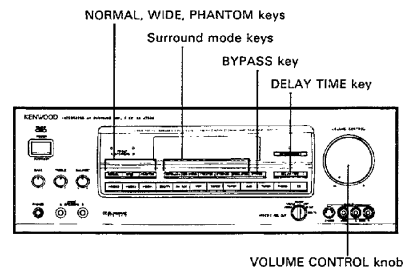
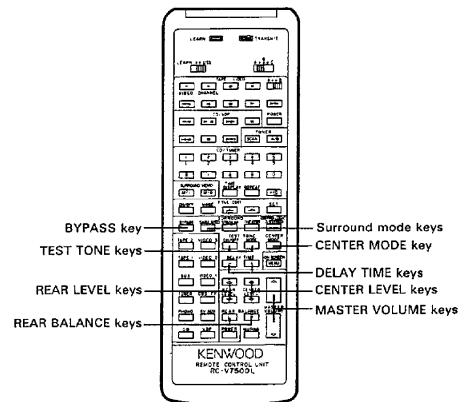

■ How to cancel the Surround mode

Press the BYPASS key.



- Be sure to set the Bypass mode whenever the Surround effects are not used.

Notes:

1. The output from the CENTER SPEAKERS terminals or CENTER OUT jack on the rear panel is output only in the NORMAL and WIDE modes of the DOLBY PRO LOGIC mode and the DOLBY 3 STEREO mode.
2. The SOURCE DIRECT key does not function while one of the Surround modes is being selected.

How to set the delay time

The delay time adjustment is required to compensate for the difference between the distance from your listening position to the front speakers and distance from your listening position to the rear (Surround) speakers. Set the optimum difference based on the following formula.

- Delay time based on the rear speaker position and listening position

$$\text{Delay time} = 20 \text{ ms} + 3 \text{ ms} \times (A_m - B_m)$$



$$20 \text{ ms} + 3 \text{ ms} \times (4\text{m} - 4\text{m})$$

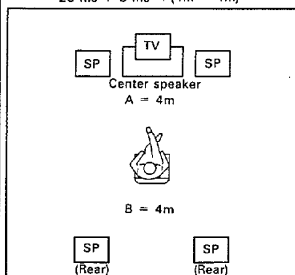

Approx. 20 ms

$$20 \text{ ms} + 3 \text{ ms} \times (3\text{m} - 4\text{m})$$

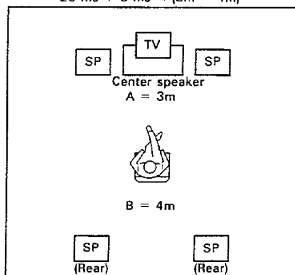

Approx. 17 ms

$$20 \text{ ms} + 3 \text{ ms} \times (4\text{m} - 3\text{m})$$

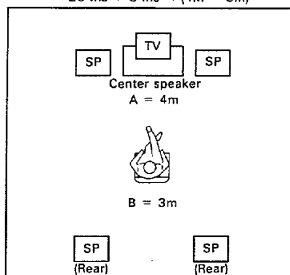

Approx. 23 ms

Example of a concert hall

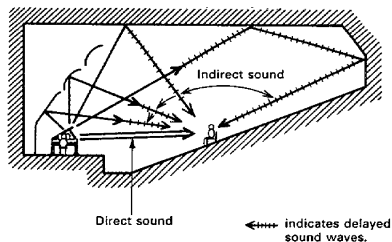

Note on delay time

As shown in this example of a concert hall, the listener hears the sound of the piano played on the stage as a composite sound consisting of the direct sound from the piano, indirect sound which are reflected by the ceiling and side and back walls before reaching the listener's ears, and reverberation sound which fades after repeating several reflections.

The indirect sound is always transmitted through a longer spatial distance than the direct sound, and the time it takes before reaching the listener is referred to as the delay time. This indirect sound with certain delay time plays a critical role in providing better sound effect and live feeling of the hall. The sound field setting in your listening room may also be dependent on the positions of the speakers. It is recommended to vary and try different delay times to obtain an optimum sound field.

Standard arrangement

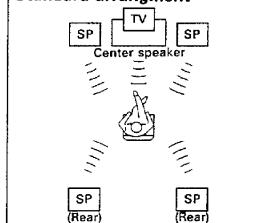

Arranging the speakers

A variety of rear speaker arrangement patterns are possible according to room size, reverberation characteristics, etc. The arrangement pattern given here is typical example for effective Surround sensation. The given example is only suggestion. Arrange the speakers according to your individual taste.

Surround information memory and Surround title lists functions

For the enjoyment in Surround modes, it is required to set the levels of the channels, delay time, etc., as described on pages 26, 27 and 28. The Surround information memory function makes it possible to store such information in memory.

Example: To enjoy a movie tape in the DOLBY PRO LOGIC mode, the operation can be completed by:

- ① Selecting the Surround mode → DOLBY PRO LOGIC
- ② Selecting the center mode → NORMAL position
- ③ Adjusting the channel levels using test tone
- ④ Setting the delay time.

Up to five sets of the setting information above can be stored in memory. The Surround title list function allows to assign a name to each set of information and store it in memory.

■ How to save Surround setup in memory

(from the remote control unit only)

1 Press the M/I (Memory Input) key.

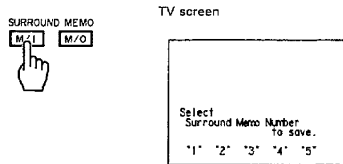

2 Save the current setup in memory.

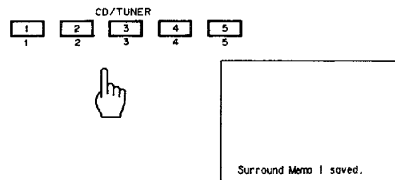

- Press desired one of the "1" to "5" keys.
- The current setup of the Surround mode, delay time, center level, rear level and rear balance is saved under the key pressed.

Note:

When the Surround mode is in the Bypass mode, the display as shown below appears and the setup cannot be saved in memory.

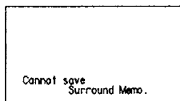

■ How to recall a Surround setup

(from the remote control unit only)

1 Press the M/O (Memory Output) key.

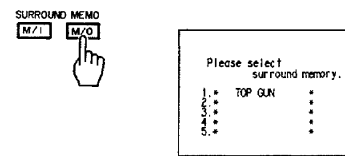

2 Recall a memory.

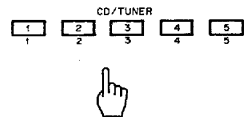

- Press desired one of the "1" to "5" keys.
- Example: Display when the "1" key is pressed

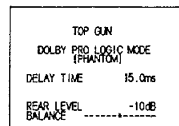

Note:

The title name is displayed when it has been input with the Title Edit function. Please also refer to "Title Edit function".

Title Edit function (Remote control unit)

The input selection display or Surround memory name on the TV screen can be replaced with a desired title. The title characters can be changed according to the components.

■ How to title-edit the model name

This function allows to enter the model name of a component used in your system.

1 Press the TITLE EDIT ON/OFF key.

TV screen



• TITLE EDIT •

Please select
MODEL NAME PRESET or
SURROUND TITLE LIST

- The display returns to the previous condition if no key has been pressed for about 15 seconds.



2 Select the component for which the model name is to be entered.

APPL.	VIDEO 1
TAPE	VIDEO 2
AUX	VIDEO 3
TUNER	OBJ./TV
PHONO	AV AUX
CD	VDP



- This can also be selected with the input selector keys on the main unit.

3 Select the desired letter or numeral.



- For the available characters, refer to Table 1 on page 31.
- TV screen when the CD input selector key is pressed

• TITLE EDIT •

Character

MODEL NAME PRESET

CD

•DP-70L•

Enter desired character

4 Establish the entry of the selected character.





- The selected character is entered, and the cursor indicating the character entry position moves to the right and blinks. Enter other characters by repeating steps 3 and 4 for each of them.
- Up to 8 characters can be entered for each model name.
- If there is another name which has been entered before, it is replaced by the new name.



5 Move the character position.

①



- The "Character" displayed on the TV screen changes to "Position".

② Press the  or  key.



- Every press of a key moves the character position toward the left or right.

6 Terminate the entry.



- The entry operation is completed and the title is changed.

Surround title list function

A title (movie name, video production title, etc.) can be saved together with the each Surround setup saved by the Surround information memory function described on page 29 (using max. 16 characters).

■ How to make a Surround title list

1 Press the TITLE EDIT ON/OFF key.

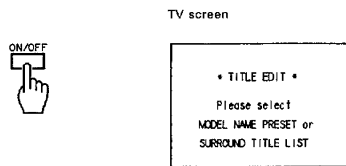

4 Establish the entry of the selected character.

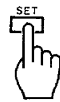

- The selected character is entered, and the cursor indicating the character entry position moves to the right and blinks. Enter other characters by repeating steps 3 and 4 for each of them.

2 Select the memory No. in which you want to save the title.

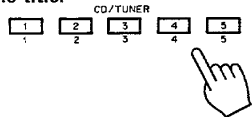

- Press one of memory No. keys "1" to "5" corresponding to the Surround information memory you want to assign a title.

5 Move the character position.

①

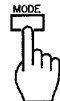

- The "Character" displayed on the TV screen changes to "Position".

②



- Every press of the or key moves the character position toward the left or right.

3 Select the desired letter or numeral.



- For the available characters, refer to Table 1 below.
- Example when "1" is pressed at step 2 above.

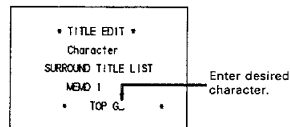

6 Terminate the entry.



- The entry operation is completed and the title is changed.

Table 1 The number of available characters is 79, which are varied in the following cycle every time the or key is pressed.

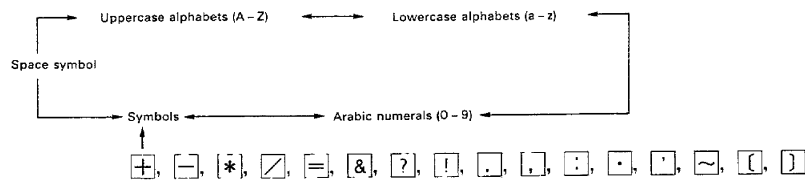

In case of difficulty

What appears to be a malfunction may not always be serious. If your unit should not perform as expected, consult the table below to see if the problem can be corrected before seeking help from your dealer or service representative.

Symptom	Cause	Remedy
When the POWER switch is set to ON, the indicators do not light and sound is not reproduced.	<ul style="list-style-type: none"> The power plug is disconnected from the power outlet. 	<ul style="list-style-type: none"> Insert in securely.
Picture and sound are not reproduced.	<ul style="list-style-type: none"> The connection cords are disconnected. The connection cords are connected improperly. The source component selected by the input selector key is different from that being played. 	<ul style="list-style-type: none"> Connect the cords securely into the jacks. Check connections, and correct as required. Press the input selector key of the component to be listened to.
Sound is not reproduced.	<ul style="list-style-type: none"> The SPEAKERS key is set to OFF. The speaker cords are disconnected. The speaker cords are short-circuited. 	<ul style="list-style-type: none"> Set the SPEAKERS key to ON. Connect the cords securely to the speaker terminals. Connect the speaker cords properly.
Sound from the rear speakers is not reproduced or is at a low volume level.	<ul style="list-style-type: none"> The Surround mode is set to BYPASS. The rear speaker level is set to the minimum position. The source is monaural while the Surround mode is Dolby Pro Logic, Theater or Stadium. 	<ul style="list-style-type: none"> Set to a desired Surround mode. Increase the rear speaker level to an optimum level. Set the Surround mode to SIMULATED.
The remote control does not work.	<ul style="list-style-type: none"> The remote controlling distance is too far. The batteries are exhausted. 	<ul style="list-style-type: none"> Operate the remote control unit from a closer position. Replace the batteries.
The DELAY TIME switch does not work.	<ul style="list-style-type: none"> The surround mode is set to STADIUM, SIMULATED, DOLBY 3 STEREO or BYPASS. 	<ul style="list-style-type: none"> The delay time cannot be adjusted in these mode.

Notes:

- Since this unit is microprocessor-controlled, malfunction may occur due to external noise or interference. In such a case, unplug the power cord first, then plug it into the power outlet while holding the TUNER key depressed. (Note that this clears the title and Surround memory.)
- Do not use contact cleaner because it could cause a malfunction. Be specially careful against contact cleaners containing oil, for they may deform the plastic components.

Memory backup feature

This unit is provided with backup circuitry for various memory functions. The memory will be backed up for a period of about 3 days while the power cord of the unit is disconnected from the power outlet. If the memory is cleared, perform the programming or storage operations again.

Speaker protection circuitry

If the speaker cords are short-circuited, the speaker protection circuitry is activated and the sound is muted. In such a case, switch the POWER key to OFF, remove the short-circuit from the speaker cords, and switch the POWER key ON again. Normal operation will resume.

Specifications (For U.S.A.)

AUDIO section

Continuous rated power output (FTC)

80 watts per channel minimum RMS, both channels driven, at 8 Ω from 20 Hz to 20,000 Hz with no more than 0.08 % total harmonic distortion.

Dynamic power

146 W (8 Ω), 237 W (4 Ω),

[SURROUND MODE]

Continuous rated power output (FTC)

Front

70 watts per channel minimum RMS, both channels driven, at 8 Ω 1 kHz with no more than 0.2 % total harmonic distortion.

Center

70 watts per channel minimum RMS, both channels driven, at 8 Ω 1 kHz with no more than 0.2 % total harmonic distortion.

Rear

18 watts per channel minimum RMS, both channels driven, at 8 Ω 1 kHz with no more than 0.9 % total harmonic distortion.

Total harmonic distortion

0.08 % (20 Hz-20 kHz, 80 W, 8 Ω)
0.02 % (1kHz, 80 W, 8 Ω)

Frequency response

LINE (CD, TUNER, AUX, TAPE) ... 5 Hz - 100 kHz,
+0 dB, -3 dB

PHONO 'RIAA' response

20 Hz - 20 kHz, +0.3 dB, -0.3 dB

Maximum Input level

PHONO (MM) 110 mV, 0.08 % T.H.D. at 1 kHz

Signal to noise ratio

PHONO (MM) ... 78 dB (IHF'66)/ 79 dB (IHF'78)
LINE (CD, TUNER, AUX, TAPE)
100dB(IHF'66)/84 dB (IHF'78)

Input sensitivity/Impedance

PHONO (MM) 2.5 mV/47 k Ω
LINE (CD, TUNER, AUX, TAPE) ... 200 mV/47 k Ω
ADAPTOR IN 200 mV/47 k Ω

Tone control

BASS ± 10 dB (at 100Hz)
TREBLE ± 10 dB (at 10kHz)

Output level/Impedance

TAPE REC 200 mV/800 Ω
ADAPTOR OUT 200 mV/800 Ω
Front channel preout 1 V/600 Ω
Center channel preout 1 V/2.2 k Ω
Rear channel preout 1 V/600 Ω

VIDEO section

Television format NTSC

Input level/Impedance

VIDEO (composite) 1Vp-p/75 Ω
Input (VIDEO 1, VIDEO 2, VIDEO 3, DBS/TV, VDP,
AV AUX)

S-VIDEO (Luminance signal) 1Vp-p/75 Ω
(Chrominance signal) ... 0.286Vp-p/75 Ω
Input (VIDEO 2, VIDEO 3, VDP, AV AUX)

Output level/Impedance

VIDEO (composite) 1Vp-p/75 Ω
Output (MONITOR OUT, VIDEO 1, VIDEO 2,
VIDEO 3)

S-VIDEO (Luminance signal) 1Vp-p/75 Ω
(Chrominance signal) ... 0.286Vp-p/75 Ω
Output (MONITOR OUT, VIDEO 2, VIDEO 3)

GENERAL

Power consumption 4 A (For U.S.A.)

Dimensions W: 440 mm (17-5/16")
H: 163 mm (6-7/16")
D: 424 mm (16-11/16")

Weight (Net) 13.7 kg (30.2 lb)

Note:

KENWOOD follows a policy of continuous advancements in development. For this reason specifications may be changed without notice.

Specifications (For other countries)

AUDIO section

STEREO MODE

Continuous rated power output (FTC)

80 watts per channel minimum RMS, both channels driven, at 8 Ω from 20 Hz to 20,000 Hz with no more than 0.08 % total harmonic distortion.

Dynamic power 146 W (8 Ω)
237 W (4 Ω)

[SURROUND MODE]

Continuous rated power output

Front (1kHz, 0.2 % T.H.D. at 8 Ω). 70 W + 70 W

Center (1kHz, 0.2 % T.H.D. at 8 Ω). 70 W

Rear (1kHz, 0.9 % T.H.D. at 8 Ω). 18 W + 18 W

Total harmonic distortion

0.08 % (20 Hz – 20 kHz, 80 W, 8 Ω)

0.02 % (1 kHz, 80 W, 8 Ω)

Frequency response

LINE (CD, TUNER, AUX, TAPE) ... 5 Hz – 100 kHz,
+0 dB, -3dB

PHONO 'RIAA' response

20 Hz – 20 kHz, +0.3 dB, -0.3 dB

Maximum Input level

PHONO (MM) 110 mV, 0.08 % T.H.D.
at 1 kHz

Signal to noise ratio

PHONO (MM) 78 dB (IHF'66)/ 79 dB (IHF'78)

LINE (CD, TUNER, AUX, TAPE)

100dB(IHF'66)/ 84 dB (IHF'78)

Input sensitivity/Impedance

PHONO (MM) 2.5 mV/47 k Ω

LINE (CD, TUNER, AUX, TAPE) ... 200 mV/47 k Ω

ADAPTOR IN 200 mV/47 k Ω

Tone control

BASS ± 10 dB (at 100Hz)

TREBLE ± 10 dB (at 10kHz)

Output level/Impedance

TAPE REC 200 mV/800 Ω

ADAPTOR OUT 200 mV/800 Ω

Front channel preout 1 V/600 Ω

Center channel preout 1 V/2.2 k Ω

Rear channel preout 1 V/600 Ω

VIDEO section

Television format NTSC

Input level/Impedance

VIDEO (composite) 1Vp-p/75 Ω

Input (VIDEO1, VIDEO2, VIDEO3, DBS/TV, VDP,
AV AUX)

S-VIDEO (Luminance signal) 1Vp-p/75 Ω

(Chrominance signal) ... 0.286Vp-p/75 Ω

Input (VIDEO 2, VIDEO 3, VDP, AV AUX)

Output level/Impedance

VIDEO (composite) 1Vp-p/75 Ω

Output (MONITOR OUT, VIDEO 1, VIDEO 2,
VIDEO 3)

S-VIDEO (Luminance signal) 1Vp-p/75 Ω

(Chrominance signal) ... 0.286Vp-p/75 Ω

Output (MONITOR OUT, VIDEO 2, VIDEO 3)

GENERAL

Power consumption 350 W (IEC)

Dimensions W: 440 mm (17-5/16")

H: 163 mm (6-7/16")

D: 424 mm (16-11/16")

Weight (Net) 13.7 kg (30.2 lb)

Note:

KENWOOD follows a policy of continuous advancements in development. For this reason specifications may be changed without notice.

**For the U.S.A.
FCC WARNING:**

This equipment may generate or use radio frequency energy. Changes or modifications to this equipment may cause harmful interference unless the modifications are expressly approved in the instruction manual. The user could lose the authority to operate this equipment if an unauthorized change or modification is made.

NOTE:

This equipment has been tested and found to comply with the limits for a CLASS B digital device, pursuant to Part 15 of the FCC Rules. These limits are designed to provide reasonable protection against harmful interference in a residential installation. This equipment may cause harmful interference to radio communications, if it is not installed and used in accordance with the instructions. However, there is no guarantee that interference will not occur in a particular installation. If this equipment does cause harmful interference to radio or television reception, which can be determined by turning the equipment off and on, the user is encouraged to try to correct the interference by one or more of the following measures:

- Reorient or relocate the receiving antenna.
- Increase the separation between the equipment and receiver.
- Connect the equipment into an outlet on a circuit different from that to which the receiver is connected.
- Consult the dealer or an experienced radio/TV technician for help.

**For CANADA
DOC REGULATION**

"This digital apparatus does not exceed the CLASS B limits for radio noise emissions from digital apparatus as set out in the radio interference regulations of the Canadian department of communications."

KENWOOD
